



COMPRESSED AIR DRYERS

No more moisture | No more water | No more oil



SUPER-DRY SYSTEMS Inc.

Super-Dry Systems is a leading manufacturer of Compressed Air Dryers specializing in the high quality filtration, separation and purification of compressed air.



D Series | Compressed Air Dryers



ATD Series | Air Tool Dryers



FC/FD Series | Mini Filters and Desiccant Dryers



FSD Series | Water Separators



FSD Series | Compressed Air Filters



TD Series | Automatic Timer Drains



SUPER-DRY

D Series | Compressed Air Dryers |

The world's highest efficiency and heavy duty
Desiccant Compressed Air Dryers at affordable prices



**LIFE
EXPECTANCY
25
YEARS**

**SUPER-DRY
10
YEAR
WARRANTY**

- Up to 300 SCFM
- Point of use dryers
- Supplement to a central system
- Zero air loss

Applications:

- | Sand Blasting | Paint Spraying | Dust Collectors | Foam Spray |
- | Air Welders | Plasma Cutting | Air Tools | Packing Equipment |



Standard Features and Benefits

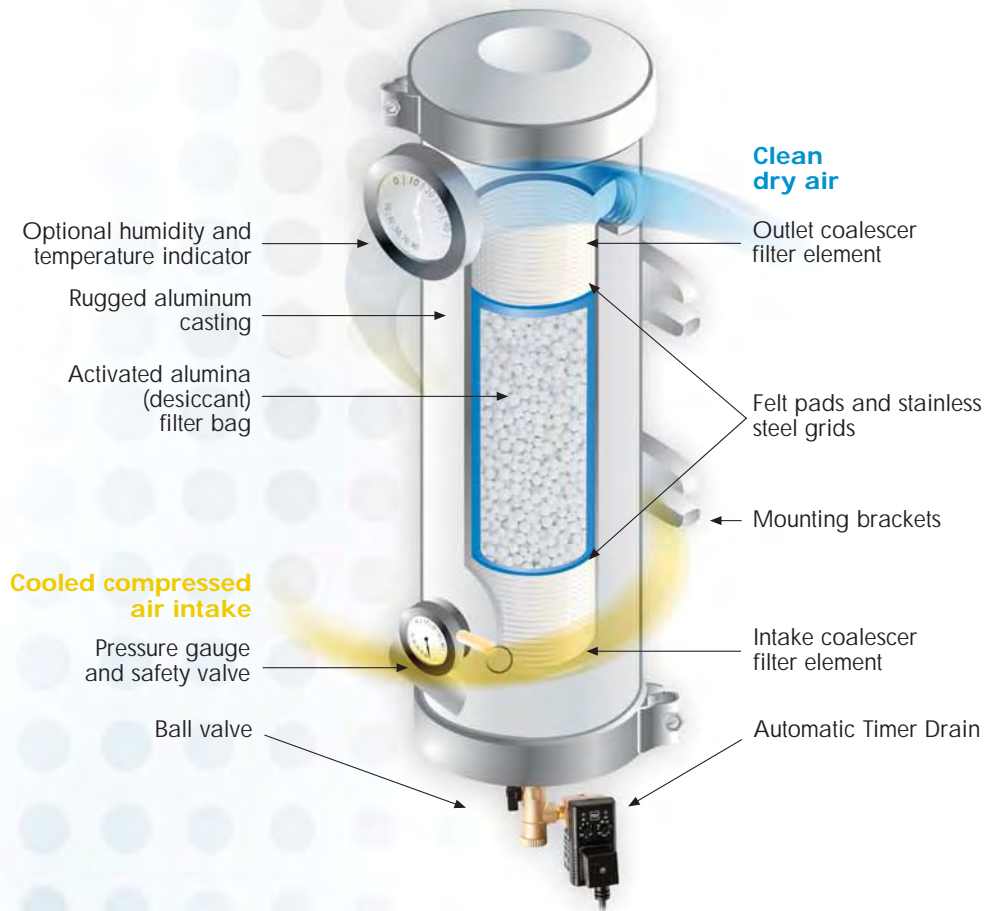

Super-Dry Compressed Air Dryers contain two highly efficient polypropylene coalescer elements at inlet & outlet ports to absorb oil and all solid air particles. Also included, one desiccant bag specifically designed to absorb water vapors and humidity from your compressed air system.

Housings for Flows up to 300 SCFM:

- Heavy duty aluminum casting for high durability and corrosion resistance
- Powder coated exterior for added durability
- Special V-band stainless steel clamps permit easy removal of covers for cartridge replacement
- Optimized air flow through housing minimizes pressure drop
- Wall mounting brackets included
- 3 stages in one unit: separation, filtration and drying

Enhanced Performance:

- Easy replaceable self-contained desiccant cartridges
- High efficiency polypropylene coalescent elements
- Optimum filter efficiency even at low air flows
- 10 year warranty
- Life expectancy: 25 years
- Pressure dew point: - 40°F
- Max. working pressure: 150 PSIG



Premium Options



- 1 Temperature and Moisture Indicator**
Indicates optimum cartridge replacement based on % relative humidity
- 2 Ball Valve & Strainer**
Isolates and protects drain
- 3 Automatic Timer Drain**
Efficient drainage of condensate
Extends the cartridge life of the dryer

Standard Accessories



Pressure Gauges, Safety Valve and Ball Valve



Replacement Cartridge

SUPER-DRY

D Series | Compressed Air Dryers |

Typical Configurations & Installations

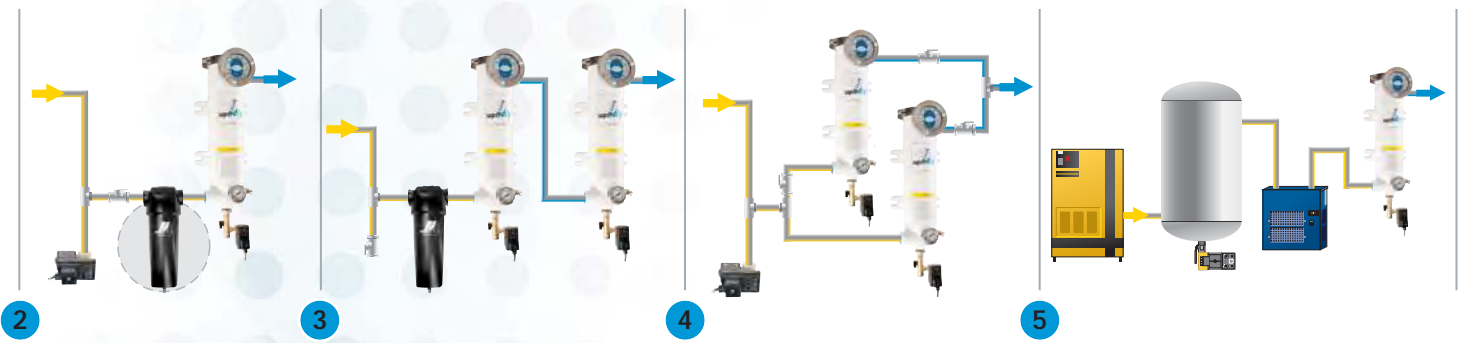
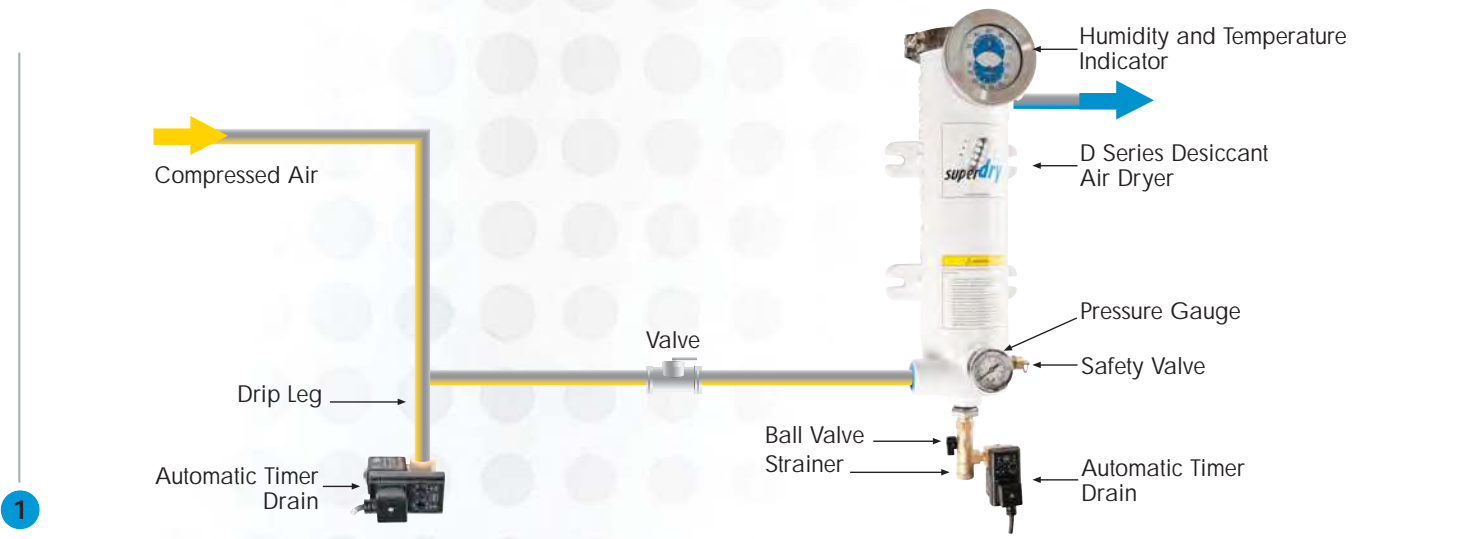

1 Recommended Configuration

- General Shop Air
- Air Tools
- Sand Blasting

2 Air / Water Separator

- Extends the life of the desiccant cartridge

3 In Series Configuration

- Provides a stable dew point

4 Parallel Configuration

- Recommended for high flows
- Maintenance without interrupting the air supply

5 Downstream of a refrigerated air dryer

- Provides lower dew point



SUPER-DRY

D Series | Compressed Air Dryers |

Specifications and Engineering Data

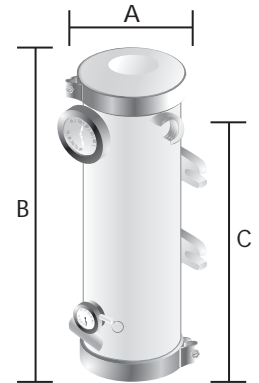

Specifications and ordering information:

Model	Air Flow @ 100 psig	Inlet/Outlet NPT in	Dimensions			Weight lbs	Replacement Kit
	scfm		A	B	C		
D-1	70	1	6	19	17 ½	20	ED-1
D-2	150	1 ½	9	20	18	40	ED-2
D-3	200	2	9	33	30	75	ED-3
D-4	300	3	11	33	29 ½	100	ED-4



Maximum inlet temperature: 100°F (38°C) Maximum inlet pressure: 150 psig

Options

			
Humidity and Temperature Indicator HGT- ¼	Automatic Timer Drain TD- ¼	Ball Valve Strainer BVS- ¼	
HGT - ¼	Relative Humidity % 10 – 80	Temperature °F 20 – 100	Connection NPT ¼
TD - ¼	Interval Time min. 0.5 - 45	Discharge Time sec. 0.5 - 10	In & Out Ports NPT ¼
BVS - ¼	Inlet Port NPT ½	Outlet Port NPT ¼	Material Brass



SUPER-DRY

ATD Series | Air Tool Dryers |

Protect your compressed air application



LIFE
EXPECTANCY
25
YEARS

SUPER-DRY
10
YEAR
WARRANTY

- High efficiency
- Portable and lightweight
- Continuous clean dry air

Applications:

| Nail Guns | Spray Painting & Coating | Airbrushes | Shot Blasting |
| Air Sampling Equipment | Automotive Workshop | Air Tool Protection |



SUPER-DRY

ATD Series | Air Tool Dryers |

Cam Lock Model also available



ATD-1/2 CL

ATD Series

Features:

- Aluminum casting
- Portable and lightweight
- Easy to use
- Quick and easy to service
- No electrical requirements

Benefits:

- Extends the life of your air-operated equipment
- Prevents air tools from freezing when working in a cold environment
- Reduces air tools maintenance costs
- Eliminate production down time

Specifications and ordering information:

Model	Air Flow @ 100 psig scfm	Inlet/Outlet NPT in	Dimensions			Weight lbs	Replacement Kit
			A	B	C		
ATD-1/4	22	1/4	10 1/8	2 5/8	1 1/2	2.5	EATD
ATD-1/2	44	1/2	10 1/8	2 5/8	1 1/2	2.5	
ATD-1/2 CL	44	1/2	10 3/4	3	1 3/4	4.2	

Maximum inlet temperature: 100°F (38°C) Maximum inlet pressure: 150 psig

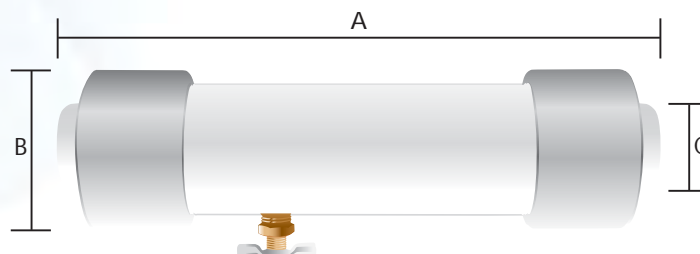

SUPER-DRY

FC/FD Series | Mini Filters and Desiccant Dryers |

| Protect your compressed air application



- High efficiency
- Portable and lightweight
- Continuous clean dry air



SUPER-DRY

FC/FD Series | Mini Filters and Desiccant Dryers |

Specifications and Engineering Data

The Super-Dry FC/FD contains:

- A coalescer filter (FC) designed to filter water, oil and other contaminants
- A miniature desiccant dryer (FD) to remove moisture from your compressed air system

Quick change replacement kit



FC / FD Series elements



FD element



FC element

Specifications and ordering information:

Model	Air Flow @ 100 psig scfm	Inlet/Outlet NPT in	Dimensions			Weight lbs	Replacement Kit
			A	B	C		
FC-½	20	½	3 ⅛	7 ½	6 ½	1.2	EFC-½
FC-1	40	1	3 ⅝	11 ⅞	10	3.8	EFC-1
FD-½	20	½	3 ⅛	7 ½	6 ½	1.2	EFD-½
FD-1	40	1	3 ⅝	11 ⅞	10	3.8	EFD-1

FC-½ & FD-½: Maximum inlet temperature: 100°F (38°C) Maximum inlet pressure: 130 psig Plastic Bowl

FC-1 & FD-1: Maximum inlet temperature: 100°F (38°C) Maximum inlet pressure: 150 psig Metal Bowl

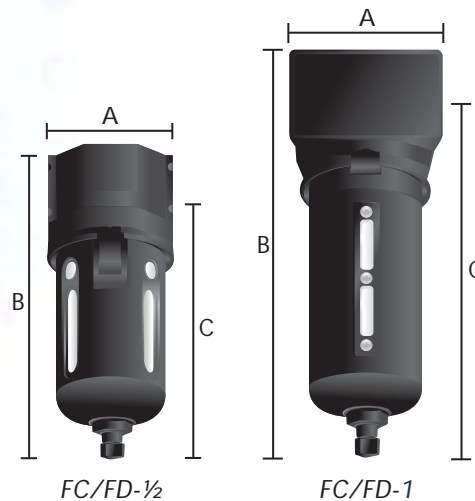

SUPER-DRY

FSD Series | Water Separators | ☰

| Bulk Liquid Removal



- **Excellent liquid removal**
- **Low maintenance**
- **Easy to install**

Super-Dry Water Separators have been designed for the efficient removal of bulk liquid contamination from compressed air.



SUPER-DRY

FSD Series | Water Separators |

Specifications and Engineering Data

Features:

- Up to 1695 scfm
- Heavy duty housing for high durability
- Zero air loss float drain included
- Excellent liquid removal efficiencies at all flow conditions



Float Drain



Pre-Filtration of Super-Dry D Series Air Dryer

Typical applications

- Protection of refrigeration dryer
- Pre-filtration of desiccant dryer
- Bulk liquid removal at the point of use
- Downstream of an after-cooler
- Protection of compressed air piping and air receivers from corrosion

Specifications and ordering information:

Model	Air Flow @ 100 psig scfm	Inlet/Outlet NPT in	Dimensions			Weight lbs
			A	B	C	
FSD-60-W	85	½	3.8	9.3	7.9	3
FSD-80-W	85	¾	3.8	9.3	7.9	3
FSD-100-W	233	1	5.1	10.8	9.2	5
FSD-180-W	233	1¼	5.1	10.8	9.2	5
FSD-300-W	742	1½	6.7	17	15	12
FSD-400-W	742	2	6.7	17	15	12
FSD-500-W	1695	3	8.1	19.9	17.5	22

Maximum inlet temperature: 176°F (80°C) Maximum inlet pressure: 232 psig

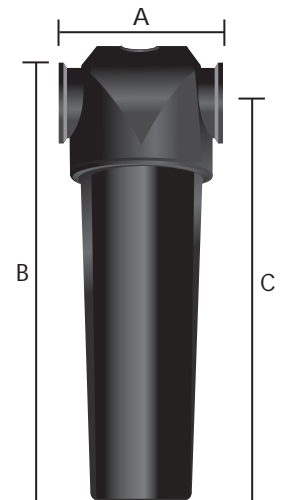

SUPER-DRY FSD Series | Compressed Air Filters |

Superior Filtration for Increased Productivity



- **No more oil**
- **No more solid air particles**
- **No more rust**
- **No more contaminants**

Super-Dry FSD Series filters effectively removes up to 99% of contaminants present in the compressed air. Clean, quality compressed air maximises air-tool service life, ensures that pneumatic machinery and control systems operate at the peak of their performance and keeps pipes & valves free from contaminants.



SUPER-DRY

FSD Series | Compressed Air Filters |

Specifications and Engineering Data

Features:

- High flow capabilities
- Low differential pressure
- Long service life
- Reliable filtration
- Simple maintenance
- Zero air loss float drain and pressure differential indicator included
- High efficiency pleated filter elements



- 1 Pressure differential indicator**
 - Visual inspection
- 2 Filter housing**
 - High grade, powder coated, aluminium casting
 - Easy filter element removal
 - Minimal pressure drop
 - Anti-corrosion protection
- 3 Element**
 - Long service life
 - Inner and outer Stainless Steel support screens
 - Pleated elements for higher filter surface
 - End caps with airtight positive «O» ring seal prevent contamination by-pass
- 4 Automatic condensate drain**
 - With float-controlled condensate drainage



Grade A - Particulate Filter

- Solid Particulate Removal: 1.0 micron
- Pressure Drop: 0.44 psi
- Oil Carry-Over: 0.5 ppm

Grade B - Coalescing filter

- Solid Particulate Removal: 0.01 micron
- Pressure Drop: 1.74 psi
- Oil Carry-Over: 0.001 ppm

Grade D - Activated Carbon

- Pressure Drop: 1.31 psi
- Oil Carry-Over: 0.003 ppm

Specifications and ordering information:

Model	Air Flow @ 100 psig scfm	Inlet/Outlet NPT in	Dimensions			Weight lbs
			A	B	C	
FSD-30	30	¼	3.43	8.23	0.83	3.3
FSD-60	60	½	3.43	10.98	0.83	3.7
FSD-100	100	¾	5.12	12.40	1.69	9.4
FSD-140	140	1	5.12	12.40	1.69	9.4
FSD-180	180	1	5.12	16.34	1.69	11
FSD-300	300	1½	5.12	20.28	1.69	12.1

Maximum inlet temperature: 176°F (80°C) Maximum inlet pressure: 232 psig

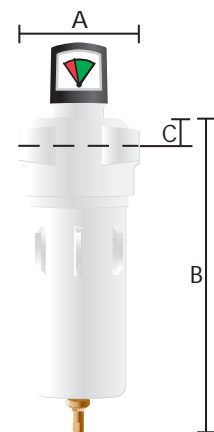



SUPER-DRY SOLUTIONS INCLUDES:

- D Series** ● | Compressed Air Dryers
- ATD Series** ● | Air Tool Dryers
- FC/FD Series** ● | Mini Filters and Desiccant Dryers
- FSD Series** ● | Water Separators
- FSD Series** ● | Compressed Air Filters
- TD Series** ● | Automatic Timer Drains



SUPER-DRY SYSTEMS Inc
2104 Francis-Hughes
Laval (Quebec) CANADA H7S 1N7

Phone: 1-888-828-1122
Fax: 1-888-828-1133
Email: info@super-dry.com
www.super-dry.com

Distributed by

